



Study of the Effect of Nitrated Hydroxyl-terminated Polybutadiene (NHTPB) on the Properties of Heterogeneous Rocket Propellants

Bogdan FLORCZAK ^{1,*}, Rafał BOGUSZ ¹,
Wincenty SKUPIŃSKI ², Michał CHMIELAREK ²,
Arkadiusz DZIK ³

¹ *Institute of Industrial Organic Chemistry,
6 Annopol St., 03-236 Warsaw, Poland*

² *Industrial Chemistry Research Institute,
8 Rydygiera St., 01-793 Warsaw, Poland*

³ *ZPS „GAMRAT” Sp. z o. o., Jasło, Poland*

**E-mail: florczak@ipo.waw.pl*

Abstract: This paper presents results from research concerning the effect of nitrated hydroxyl-terminated polybutadiene (NHTPB), content up to 3%, on the physico-chemical, physico-mechanical and ballistic properties of heterogeneous rocket propellants based on hydroxyl-terminated polybutadiene (HTPB), ammonium perchlorate (AP) and aluminium powder. The results of research on the rheological and thermal properties of the tested solid rocket propellants are also presented. These studies have shown that 2% rubber NHTPB, contained within a composite solid propellant, increases the energy and ballistic parameters of the propellant.

Keywords: NHTPB, HTPB, heterogeneous solid rocket propellant, linear burning rate

1 Introduction

In the technological process of producing heterogeneous rocket propellants we are dealing with a highly filled suspension of a pasty consistency, in which the solid phase consists mainly of a powdered oxidant and aluminium. The most

commonly used oxidant is ammonium perchlorate (AP). The liquid phase (binder) consists of butadiene rubber with hydroxyl groups (HTPB), a plasticizer, typically dioctyl adipate (DOA), and a di-isocyanate (DDI – Dimeryl Di-Isocyanate) as a curing agent. After the above-mentioned slurry has been cured, a rubber-like solid with specific properties is obtained.

The most recent trend in the technology of solid rocket propellants is the search for modern, high-energy liquid chemicals which are expected to improve the energetic properties of the rocket propellants, as well as improve the physico-chemical, physico-mechanical and ballistic properties. The relevant research has led to the synthesis of high-energy polymeric compounds, such as glycidyl azide polymer (GAP), the polymer from 3-nitratomethyl-3-methyloxetane (polyNIMMO), or butyl-2-nitratoethylnitramine (Bu-NENA) [1], each of which can be used as components in binders. These compounds, however, are marked by a much lower compatibility with other propellant components than HTPB, a higher glass transition temperature which limits their applicability and a high cost of obtaining them. By contrast, additives may be structurally separate items, like catocene, or rubber derivatives such as Butacene®, increasing the rate of propellant combustion. On the other hand, nitrated hydroxyl-terminated polybutadiene (NHTPB, Figure 1), characterized by a higher molecular energy than HTPB due to the statistically distributed nitrate ester groups in the molecule, seemed worth investigating in terms of its actual effect on selected properties of heterogeneous rocket propellants.

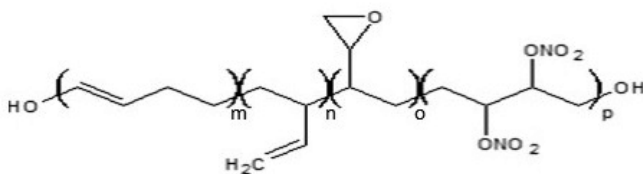

Figure 1. Formula structure of NHTPB.

A propellant's ballistic properties are characterized, inter alia, by its linear burning rate (r) and the latter's dependency on pressure and temperature, $r = f(p, T_p)$ where p is the pressure at which the burning of the heterogeneous solid rocket propellant (HSPR) occurs and T_p is the propellant initial temperature. One research method which allows indirect determination of the burn rate by reference to pressure, based on the recorded $p = f(t)$ characteristics and the dimensions of the tested propellant sample, uses a laboratory rocket motor system

(LRM) [2-7] or a subscale rocket motor (SRM) [8]. It was this method which the authors have employed in the research, using an LRM of their own design, in which a cuboid-shaped propellant sample is burned [9].

2 Experimental

Experiments related to: obtaining NHTPB, a method for obtaining samples of propellant and research on the rheological properties of slurry propellants, their calorific value, sensitivity to mechanical stimuli, decomposition temperature and ballistic properties.

2.1 Preparation NHTPB and propellant samples

The NHTPB was obtained in a two-stage synthesis (Figure 2), by epoxidation of HTPB (stage 1) and nitration of this intermediate product (stage 2). The reaction degree was assessed by an analysis of the ^1H NMR spectra, by observing the occurrence of peaks due to hydrogen atoms during the formation/cleavage of the oxirane rings.

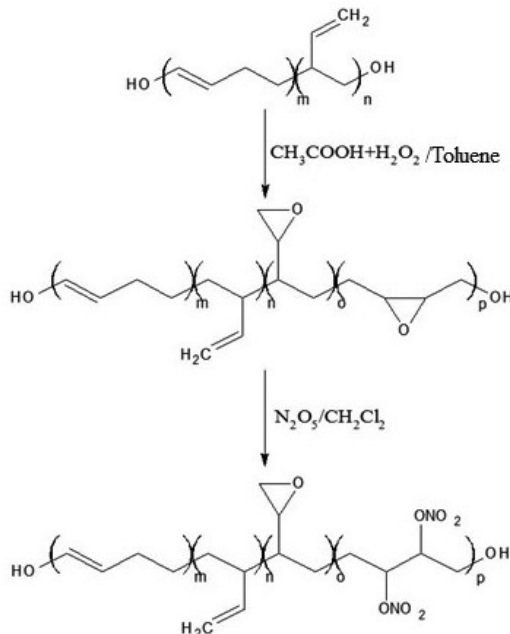

Figure 2. Scheme for the synthesis of NHTPB.

The following substances were used for the epoxidation: analytical grade toluene (POCH S.A.), analytical grade 99.9% acetic acid (POCH S.A.), analytical grade 60% hydrogen peroxide (Chempur) and HTPB (Industrial Chemistry Research Institute). Analytical grade methylene chloride (POCH S.A.) and dinitrogen pentoxide (Industrial Chemistry Research Institute) were used in the nitration process. Due to the selective nature of the nitration process, some oxirane rings remained within the molecular structure in the vinyl branches of the polybutadiene chain [10, 11]. The product obtained was analysed to determine its basic properties and to compare them with the properties of HTPB (Table 1).

Table 1. Properties of HTPB and NHTPB

Parameter	HTPB [11]	NHTPB [10]
Number average molecular weight (Mn)	2800	3991
Weight average molecular weight (Mw)	6160	11415
Coefficient of dispersion	2.2	2.86
Hydroxyl value, [meq/g]	0.72	1.25
Viscosity (30 °C), [mPas]	4400	3400
% of ONO ₂ groups	-	8.86
% of epoxy groups	-	2.46

The amount of epoxy and nitrate esters groups was determined by comparing the spectra of an epoxidised HTPB with a known amount of epoxy groups, with the NHTPB spectrum, which was obtained according to the reaction shown in Figure 2.

The disappearance of the hydrogen peaks within the epoxy groups bear witness to the formation of nitrate groups, and elemental analysis allows the accurate calculation of the resulting nitrate esters groups. The NHTPB obtained as above was used to prepare four propellant formulations *i.e.* P1, P2, P3 and P4 (Table 2), in which the NHTPB percentage was 0.675%, 0.99%, 1.35% and 2.7%, respectively.

The following materials were used to prepare the propellants: HTPB and DDI (IPI), DOA (Boryszew ERG SA), Al powder (Benda-Lutz). The above-mentioned formulations had been mixed in a vertical planetary action mixer at 60 °C under reduced pressure. After the mixing cycle, the propellants were cast under vacuum into moulds and left to cure in a drier for 7 days, at a temperature of 65 °C instead of 60 °C, in order to accelerate the curing process. After curing, the propellants were subjected to thermo-chemical tests (decomposition temperature, calorific value), mechanical sensitivity tests and ballistic tests (Institute of Industrial Organic Chemistry).

Table 2. Composition of the propellants prepared (in wt.%)

Ingredients	Propellants tested				
	P0*	P1	P2	P3	P4
HTPB	9.010	8.553	8.234	7.870	6.498
NHTPB	-	0.675	0.990	1.350	2.700
DOA	2.110	2.110	2.110	2.110	2.110
AP	70.070	70.070	70.070	70.070	70.070
Al	16.010	16.010	16.010	16.010	16.010
DDI	2.050	1.832	1.836	1.840	1.862
Additives**	0.750	0.750	0.750	0.750	0.750

* P0 = heterogeneous solid rocket propellant (HSPR P2) [12];

** Lecithin, catocene, antioxidant (AO), bonding agent (Hx-752), oxalic acid + glycerine (OA+G) [13].

2.2 Rheological properties

From a technological point of view, it is not only the practical (exploitable) properties of the cured propellant that are of interest, but also the properties of the propellant composition, which is a unique highly filled suspension, at the time of casting. Therefore, studies on the apparent viscosity of the propellant composition were carried out as a function of time during the propellant slurry curing process, at a temperature of 60 °C. For this purpose a viscometer HADV-II + PRO with a Helipath stand, a T-D spindle and an ultrathermostat TC-550 SD Brookfield were used. The Helipath stand provided a slow helical movement of the spindle at a speed of 2.22 cm/min, which helped to eliminate the so-called tunnel effect. Before the measurements were started, the spindle was immersed to a depth of 7 mm below the surface of the propellant slurry. All measurements were performed using a Brookfield Rheocalc programme and the same type and design of spindle. The tests were run as an automated viscosity measurement according to a programmed measurement procedure using a simple programming language, B.E.A.V.I.S (Brookfield Engineering Advanced Viscometer Instruction Set). The spindle rotation speed would change in a programmed manner if the rheometer reached a specified percentage torque limit. Figure 3 shows the viscosity curves for the tested propellants and these were used to determine the propellant composition pot life, *i.e.* the period during which propellant charges can be formed by casting.

As can be seen, the curves for propellants P1, P2 and P3 reached the technological boundary value of propellant fluidity (1,500 Pas) [14] after about 4 hours. Additionally, an offset towards lower viscosity values is visible between the first and second halves of these curves for the propellants with a lower

percentage of the NHTPB additive. For propellant P4, containing 2.7% of NHTPB, the viscosity already exceeds the boundary value of 1.5 kPas at the start of the measurements, reaching 1.9 kPas and then 4.9 kPas after 30 minutes. For that reason, sample P4 was discarded from further study as a technological outlier.

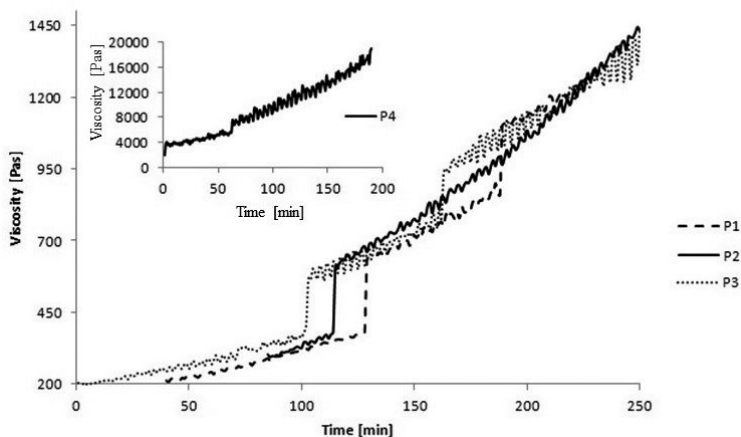

Figure 3. Viscosity curves of the samples tested. The changes in viscosity with time for the propellant P4 is shown in the upper graph due to the much higher viscosity change.

2.3 Determination of the calorific values

The measurement of the calorific value (Q) or the isochoric heat of combustion were made using an adiabatic bomb calorimeter IKA C 4000. The weight of the samples tested was 5.8 g. Two measurements were made for each of the propellants. They differed from each other by less than 25 J/g, and were used to calculate the average calorific value. The results are presented in Table 3. As shown in Table 3, the increase in calorific value for propellant samples P2 and P3 was about 3%, compared to the reference sample (P0), while for P1 the increase was about 5.5%.

Table 3. Calorific values for the propellants tested

Propellant sample	Average calorific value, [J/g]
P0	6417
P1	6772
P2	6630
P3	6632

2.4 Friction and impact sensitivity

The test methods (Test 3 (a) (ii): BAM Fallhammer, and Test 3 (b) (i): BAM friction apparatus) used in the investigation are described in detail in [15, 16]. The test results are shown in Table 4.

As can be seen, the propellants which contain NHTPB show an increase in friction sensitivity and a decrease in impact sensitivity, compared to the P0 propellant which contains no NHTPB.

Table 4. Friction and impact sensitivity values for the propellants

Propellant sample	Sensitivity	
	Friction, [N]	Impact, [J]
P0	120	7.5
P1	60	10
P2	60	10
P3	80	10

2.5 Decomposition (initiation) temperatures

The decomposition temperature was determined experimentally by heating a sample of specified weight at a constant rate until it was transformed by deflagration (fume-off). The decomposition temperature was measured by two methods. In the first (Method I), the results from differential thermal analysis (DTA) were used. In this method, the samples were heated at a constant rate while the physicochemical processes taking place inside them were registered on the basis of heat absorption. An OZM Research DTA 551-Rez apparatus was used for the DTA measurements. The sample weight was 30-40 mg and the measurements were made within a temperature range of 30-450 °C. In the other method (Method II), propellant samples of about 0.5 g were placed in glass test tubes and immersed in a Wood's alloy bath at a temperature of 100 °C [17]. In both methods, the temperature was increased at 5 °C/min. Figure 4 shows the DTA curves, while Table 5 lists the results obtained.

The decomposition temperatures obtained by the two methods differed from each other because they describe different stages of decomposition. The transcristalline transformation of AP at about 240 °C was observed on the DTA curves.

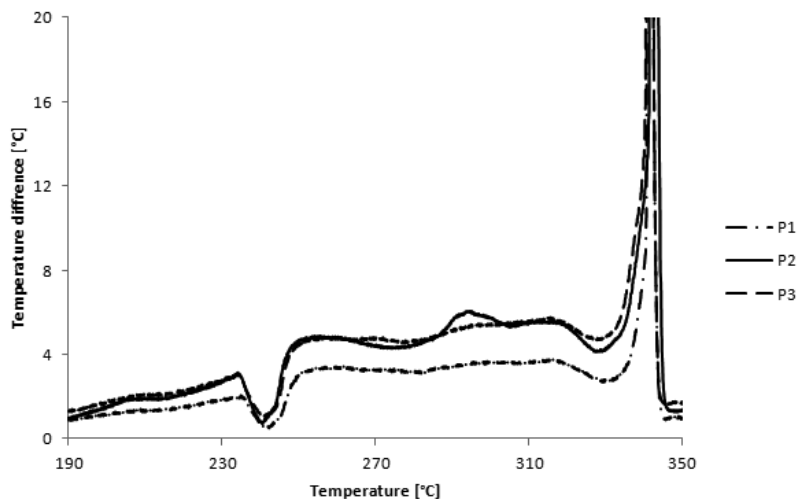

Figure 4. DTA thermograms of the propellants tested.

Table 5. Decomposition temperatures of the propellants tested

Propellant sample	Decomposition temperature, [°C]	
	Method I*	Method II
P0	-	262
P1	341	305
P2	341	312
P3	340	342

* Onset temperature.

2.6 Study of the ballistic properties

To study the ballistic properties of the composite propellants containing NHTPB, a laboratory rocket motor with a charge shaped plate was used.

The adopted method assumes that:

- (1) the ideal gas law can be applied to the combustion products;
- (2) the flow in the nozzle is one-dimensional and isentropic;
- (3) the nozzle critical cross-section during combustion is constant and does not change;
- (4) the propellant burns in parallel layers in a direction perpendicular to each surface of the slab;
- (5) c^* assumes a constant value over the full pressure range.

The mass flow through the nozzle is expressed by the formula:

$$dm/dt = p_c A_t / c^* \tag{1}$$

where:

dm/dt = mass flow through the nozzle; p_c = chamber pressure; A_t = critical cross-section of the nozzle; c^* = characteristic speed.

By integrating Equation (1), we obtained:

$$m_p = \frac{1}{c^*} \int_{t_1}^{t_3} p_c A_t dt \tag{2}$$

where:

t_1 is the burning start time, assumed for $p = 0.1 p_m$ (p_m = maximum pressure), t_3 is the motor operation end time assumed for $dp^2/dt^2 = 0$ for $t \cong t_3$ (Figure 7), and m_p is the total weight of the charge tested.

The propellant mass flux during the time from t_1 to the time t , varying in the range $t_1 \leq t \leq t_2$, is:

$$m(t) = \frac{1}{c^*} \int_{t_1}^t p_c A_t dt \tag{3}$$

assuming $A_t = \text{const}$

$$\frac{m(t)}{m_p} = \frac{\int_{t_1}^t p_c dt}{\int_{t_1}^{t_3} p_c dt} \tag{4}$$

$$m(t) = r_p V(t) \tag{5}$$

$$m_p = r_p V_p \tag{6}$$

where r_p , V_p , $V(t)$ are the density, the initial volume of the propellant and the volume after time t , respectively.

After substituting (5 and 6) in Equation (4), we obtained:

$$V(t) = V_p \frac{\int_{t_1}^t p_c dt}{\int_{t_1}^{t_3} p_c dt} \tag{7}$$

The values of V_p , p_c , t and A_t were obtained by measurement.

The dependences below served to determine the linear burn rate $r(p)$ by an indirect method:

$$\frac{dV}{dt} = S_p(x) \cdot r \quad (8)$$

$$\frac{dV}{dt} = V_p \frac{p_c}{\int_{t_1}^{t_3} p_c dt} \quad (9)$$

$$S_p(x) = S_{p0} + 24x^2 - 8(a + b + c)x \quad (10)$$

$$S_{p0} = 2(ab + ac + bc) \quad (11)$$

where $S_p(x)$ is the surface of the propellant sample burned, x is the thickness of the burned propellant layer and a , b , and c are the initial dimensions of the propellant sample tested.

By solving Equation (12) using the WolframMathematica®10 software we obtained:

$$S_p[x/.NSolve[\{V(x)-V(t)=0, x \leq (c/2)\}, x]] \text{ for } t_m \leq t \leq t_2 \text{ in step } \Delta t = 0.01 \text{ s} \quad (12)$$

$$V(x) = 8x^3 - 4(a + b + c)x^2 + S_{p0} \cdot x \quad (13)$$

The values of $S_p(x)$ at the relevant times t enabled the linear burning rate to be determined from Equation (8), where $r = (dV/dt)/S_p(x)$ and matches the corresponding pressure in the data table $\{p, r\}$.

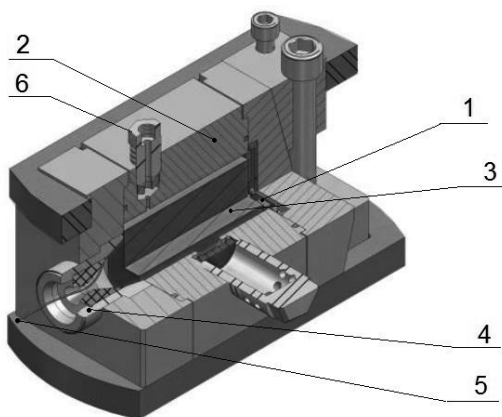

Figure 5. Cross section of the LRM with a slab charge: 1 – igniter, 2 – combustion chamber, 3 – propellant, 4 – nozzle, 5 – ignition wires, 6 – pressure sensor port [9].

The above methodology has enabled the propellant burn rate to be determined based on the $p=f(t)$ characteristics recorded during combustion of the propellant samples in the LRM system (Figure 5).

The charges used for testing were cuboid-shaped slabs (Figure 6) with the dimensions of $a=5$ cm, $b=10$ cm and $c=2.5$ cm.

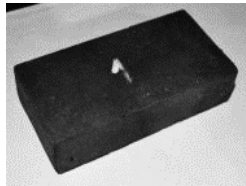

Figure 6. Sample of the propellant slab charge.

The characteristics of $p=f(t)$ recorded during the propellant tests are shown in Figures 7-9, whilst the identification of relevant points on one of the curves is given in Figure 7. The linear burn rate values of the propellants tested, calculated with reference to pressure, are shown in Figures 10-12.

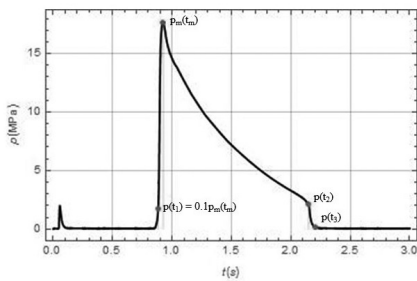

Figure 7. Dependence of $p=f(t)$ for propellant P1.

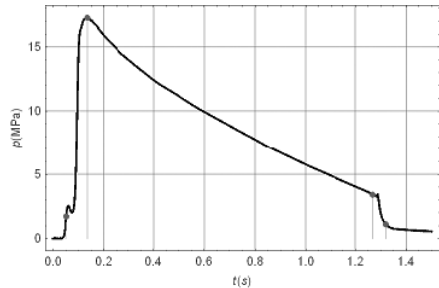

Figure 8. Dependence of $p=f(t)$ for propellant P2.

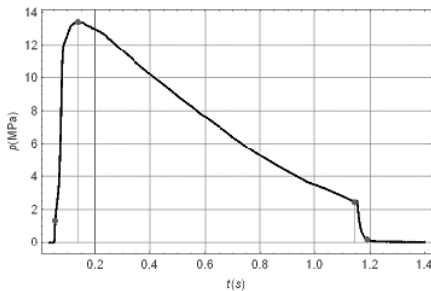

Figure 9. Dependence of $p=f(t)$ for propellant P3.

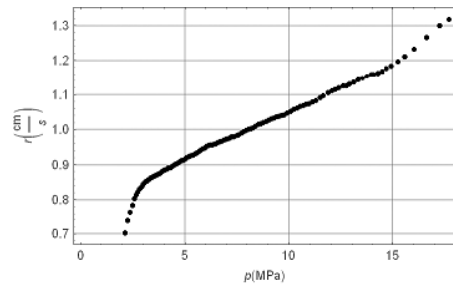

Figure 10. Dependence of $r=f(p)$ for propellant P1.

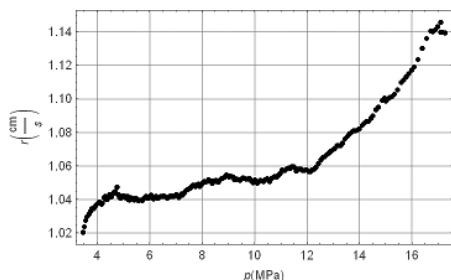

Figure 11. Dependence of $r=f(p)$ for propellant P2.

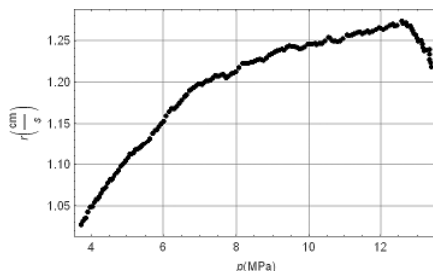

Figure 12. Dependence of $r=f(p)$ for propellant P3.

Clearly visible on the above $r=f(p)$ curves are three intervals of linear burn rate change corresponding to pressure. The chart in Figure 11 is significant as it shows a plateau within the pressure interval of 5 to 12 MPa.

3 Conclusions

The study has shown the possibility of using NHTPB as a rocket propellant additive in amounts up to between 10 and 20 wt.% relative to HTPB. The NHTPB-containing propellants are characterised by approx. 3-5% increase in energy content.

The propellants which contain NHTPB show an increase in friction sensitivity and a decrease in impact sensitivity, compared to the propellant which contains no NHTPB. Moreover, NHTPB was seen to increase the decomposition temperature of the samples tested.

Interesting dependencies of the linear burn rate on pressure have also been observed. Propellant P3 has the highest linear burning rate of 1-1.3 cm/s.

A test method employing slab-shaped propellant samples in an LRM system and a procedure for indirect determination of the linear burn rate by reference to pressure, using the WolframMathematica®10 software, requires fewer tests compared to other methods, for the determination of the dependence of linear burn rate on pressure within a wide range.

The research has shown that the NHTPB rubber content influences the character of linear burning rate changes corresponding to pressure for three distinctive pressure ranges for propellants: for P1 2-3, 3-15 and above 15 MPa; for P2 below 5, 5-12 and 12-17 MPa and for P3 4-7, 7-13 and above 13 MPa. The use of rubber NHTPB improved the ballistic properties of the composite solid propellants. The addition of a small amount of rubber NHTPB (<2%) can

affect the energy (Table 3) and the ballistic properties (Figures 10-13) of the composite solid propellants.

An increase in the rubber content of more than 2.7% causes an increase in the viscosity of the propellant slurry, and thus shortens its lifetime, which is undesirable from the point of view of the production technology of propellant charges.

Acknowledgements

This work was supported by the Polish Ministry of Science and Higher Education from 2012–2015, as Applied Research Programme No. 180743.

4 References

- [1] Agrawal J.P., *High Energy Materials*, Wiley-VCH Verlag GmbH & Co. KGaA, Weinheim **2010**, pp. 254, 257, 271; ISBN 9783527326105.
- [2] Colclough M.E., Paul N.C.; Nitrated Hydroxyl-terminated Polybutadiene: Synthesis and Properties; *ACS Symposium Series, American Chemical Society*: Washington, DC, **1996**.
- [3] Florczak B., Białek M., Cholewiak A., Determination of the Internal Ballistic Properties of Solid Heterogeneous Rocket Propellants, *Cent. Eur. J. Energ. Mater.*, **2014**, 11(4), 589-601.
- [4] Maggi F., DeLuca L.T., Bandera A., Burn-rate Measurement on Small-scale Rocket Motors, *Defence Sci. J.*, **2006**, 56, 353-367.
- [5] NATO RTO Technical Report (RTO-TR-043); AC/326 (AVT-016)TP/28), *Evaluation of Methods for Solid Propellant Burning Rate Measurement*, NATO-RTO, Neuilly-Sur-Seine Cedex, France, **2002**.
- [6] Fry R.S., Gadiot G.M.H.J.L., *Burning Rate Measurement Analysis Methods*, Chapter 4, Report No. RTO-TR-043, **2002**; (Table 4.6).
- [7] Florczak B., Białek M., Szczepanik M., Dzik A., Research on the Elaboration of Heterogeneous Solid Rocket Propellant for Cargo Associated with the Wall of the Engine Compartment, *Chemik*, **2013**, 67(1), 25-32.
- [8] Florczak B., Investigation of an Aluminized Binder/AP Composite Propellant Containing FOX-7, *Cent. Eur. J. Energ. Mater.*, **2008**, 5(3-4), 65-75.
- [9] Florczak B., Kwilosz S., Cholewiak A., Białek M., Miszczak M., *Laboratory Rocket Motor* (in Polish), Patent Application PL 407403, **2014.03.05**.
- [10] Bogusz R., *Research on Obtaining Solid Rocket Propellants Based on Hydroxyl-terminated Polybutadiene with Nitroester Groups* (in Polish), Thesis work, Warsaw University of Technology, **2014**.
- [11] Chmielarek M., Skupiński W., Wieczorek Z., Dziura R., α,ω -Dihydroxypolybutadiene (HTPB). Properties and Production (in Polish), *Przem. Chem.*, **2012**, 91(8), 1803-1807.

- [12] Sałaciński T., Florczak B., Buczkowski D., Testing of the Sensitivity of Composite Solid Rocket Propellants (in Polish), *Przem. Chem.*, **2014**, 93(2), 203-205.
- [13] Florczak B., Viscosity Testing of HTPB Rubber Based Pre-binders, *Cent. Eur. J. Energ. Mater.*, **2014**, 11(4), 685-637.
- [14] Chandrasekharan P., Manufacture of Heterogeneous Solid Propellants, in: *Propellant and Explosive Technology*, (Krisnan S., Chakravarthy S.I., Athithan K.S., Eds.), Allied Publishers Ltd, **1998**, 125-148; ISBN 8170235546.
- [15] Florczak B., Sałaciński T., Maranda A., Sitkiewicz-Wołodko R., Test of Sensitivity of Double-base Propellants (in Polish), *Przem. Chem.*, **2013**, 92(8), 1464-1471.
- [16] Recommendations on the Transport of Dangerous Goods. Manual of Tests and Criteria. Fifth revised ed., ST/SG/AC.10/11/Rev.5, UN, New York and Geneva, 2009; ISBN 9789211391350.
- [17] Suceska M., *Test Method for Explosives*, Springer-Verlag, New York, 1995; ISBN 9781461269045.