



Research paper / Praca doświadczalna

Preliminary studies of a selected group of propellants with potential application in dry fracking technology *Badania wstępne wytypowanej grupy paliw o potencjalnych możliwościach ich zastosowania w technologii suchego szczelinowania*

Justyna Hadzik^{1,*}, Piotr Koślik¹, Zenon Wilk¹, Antoni Frodyma², Łukasz Habera²

¹ Institute of Industrial Organic Chemistry**, Branch in Krupski Młyn,
1 Zawadzkiego Street, 42-693 Krupski Młyn, Poland

² Oil and Gas Institute – National Research Institute, 25A Lubicz Street, 31-503 Kraków, Poland

* E-mail: justyna.hadzik@ipowaw.pl

** now called: Lukaszewicz Research Network – Institute of Industrial Organic Chemistry

Abstract: The aim of this paper is the selection and study of solid propellants intended for uses associated with the intensification of oil and gas mining, including extraction from shale formations. Results of the study are connected with cooperation with the Department of Shooting Engineering at the Oil and Gas Institute – National Research Institute in Kraków. The basic research is the selection of a group of solid propellants and their modification to the stage where their properties and operating parameters are appropriate for dry fracking. The paper presents research methods for determining the parameters of their propellants in a laboratory-scale rocket motor, e.g. the amount of pressure impulse. Furthermore, an effective electrical system of ignition and a method of appropriate propellant sample inhibition were implemented in order to control the sample combustion process.

Streszczenie: Temat pracy związany jest z doбором i badaniami paliw stałych przeznaczonych do zabiegów związanych z intensyfikacją wydobycia ropy i gazu, w tym również z formacji łupkowych. Opracowanie jest rezultatem aktualnej współpracy z Zakładem Techniki Strzelniczej w Instytucie Nafty i Gazu – Państwowym Instytucie Badawczym w Krakowie. Podstawowym założeniem badawczym jest wytypowanie grupy paliw stałych, ich badania i modyfikacje do etapu, w którym ich właściwości i parametry użytkowe będą właściwe dla technologii suchego szczelinowania. W pracy zaprezentowano metodykę badawczą dla określenia parametrów wytypowanych paliw w układzie laboratoryjnego silnika, np. wielkości impulsu ciśnienia. Ponadto zaimplementowano skuteczny elektryczny układ inicjacji zapłonu paliw oraz sposób właściwego inhibitowania próbek paliw do badań w celu ukierunkowania procesu spalania próbek.

Keywords: propellants, laboratory rocket motor, dry fracking

Słowa kluczowe: paliwa stałe, silnik laboratoryjny, suche szczelinowanie

1. Introduction

Natural gas and crude oil deposits are found all over the world and are accumulated in various types of sedimentary rock, e.g. sandstone, limestone and shale. There are two types of gas and oil occurrence: conventional and unconventional. Conventional deposits are hydrocarbons accumulated in natural traps, in porous (permeable) rocks covered with a layer of impermeable rocks, while unconventional deposits are hydrocarbons accumulated in impermeable rocks. Porous rocks, such as sandstone, are characterized by high permeability, due to the tiny pores in the rock being well connected allowing for the free flow of gas in the rock. Due to the high permeability, conventional deposits flow easily to an accumulation site, from which they can be relatively easily extracted by making a borehole [1].

Currently, unconventional deposits worldwide are almost twice as large as conventional deposits. Unconventional deposits are defined as raw materials which require specific techniques for their extraction. These are primarily shale gas, bound gas and coal bed methane. Shale gas is the natural gas accumulated in shale rocks. Unlike permeable rocks, shale does not allow free flow of gas within its structure. For this reason, gas extraction from these rocks requires the application of other technologies – i.e. hydraulic fracturing, which consists in creating fractures to connect the pores in the rock, thanks to which free flow of gas is possible [1].

So far, hydraulic fracturing is the best-known technology worldwide for obtaining hydrocarbons from unconventional deposits, including natural gas from shale. It is a well established and mastered technology involving, however, the investment of technical, material and human resources is significant, and is relatively expensive.

An alternative to hydraulic fracturing is EPS (Explosive/Propellant System) dry fracturing. This system is based on the combination of explosive charges and solid propellant. As a result of detonating explosives, multi-stage propellant combustion occurs [2, 3]. EPS dry fracturing has a number of advantages:

- increases the length of the cracks by 10-50 m,
- eliminates problems like compatibility between the fracturing fluid and deposit, wetting shales, their swelling, deposit plugging, leaching of heavy and light metals,
- the entire section of the horizontal borehole is fractured; therefore, gas flow may even be close to the level of hydraulic fracturing,
- takes up less space, requires the involvement of fewer employees and specialized equipment.

The research topic is a continuation of the work carried out in the Institute of Industrial Organic Chemistry by teams both in Krupski Młyn and in Warszawa (Department of High Energy Materials), related to the intensification of oil and gas extraction, including extraction from shale formations [4, 5]. This research is also associated with cooperation with the Department of Shooting Engineering of the Oil and Gas Institute in Kraków in implementing new components and technologies for perforating and fracturing works in national wells. The article presents a fragment of the work performed, potentially suitable propellants for dry fracturing are presented as is a method for their testing using a static laboratory-scale rocket motor to determine their ballistic properties.

1.1. Propellants used in the oil industry

Solid propellants can be grouped as homogeneous or composite (heterogeneous). In turn, homogeneous propellants can be further classified as single, double or triple base. Single-base propellants consist of one main component, nitrocellulose, which has both oxidizing and reducing properties. The main components of double base propellants are nitrocellulose and nitroglycerine with added plasticizers, burning rate modifiers and stabilizers. Composite propellants used in oil extraction are a mixture of a solid inorganic oxidant (ammonium chlorate(VII), NH_4ClO_4 , or ammonium nitrate(V), NH_4NO_3) constituting 60-90% of the mass of the entire propellant and various types of additives (organic and inorganic compounds and elements), both in the liquid and solid state, acting as technical, energetic and ballistic additives [6-9].

There are no stringent requirements for the structure of propellants produced for fracking applications (as opposed to the needs of rocket propulsion), but appropriate parameters are important, usually lower combustion rates and reliability of ignition at high temperatures and pressures. What is needed is the configuration

of the propellant applied, which is convenient for the production of appropriate propellant elements, adapted to the construction of downhole equipment used in mining. Moulding or casting technologies will be economical in these applications.

2. Materials and methods

The article mainly concerns propellant ignition tests in a static laboratory-scale motor. For this purpose, a motor with a set of exhaust nozzles was designed and manufactured, samples of several types of propellants were prepared and a series of combustion tests of a selected group of propellants was carried out together with pressure recording. The stage of preparation of propellant samples for testing in the motor also included manufacturing the necessary propellant ignition system and coating the propellant surface with a so-called inhibitor in order to control combustion of the sample.

2.1. Preparation of the test stand

A laboratory-scale motor was designed and built for testing the selected propellants. It is a static device for testing the basic parameters of propellants such as burning rate and combustion pressure. Figure 1 shows the design of a classic motor adapted for the purposes of this research subject.

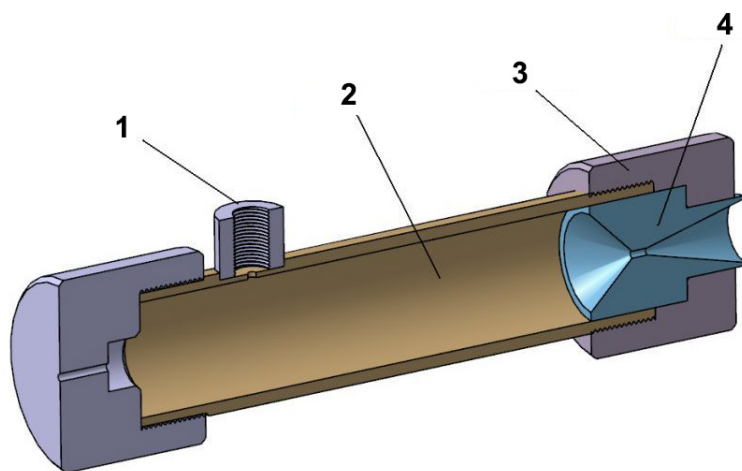

Figure 1. Cross-section of the laboratory motor for propellant ignition and combustion tests: 1 – measurement probe, 2 – case, 3 – head, 4 – nozzle

A replaceable graphite nozzle (4) was placed in the head (3) visible in Figure 1. The case (2) had a measurement probe (1), into which a piezoresistive pressure transducer was screwed, transmitting the signal to an oscilloscope. A part of the motor, with the head and nozzle, is shown in Figure 2.

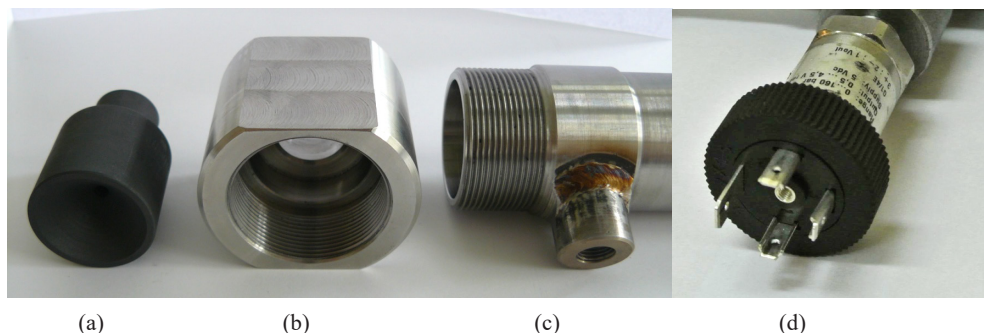

Figure 2. View of a part of the laboratory motor for testing propellants: (a) ejector nozzle, (b) motor head in which the nozzle is placed, threaded end part of the body allowing for retightening the head, (c) measurement probe for mounting the pressure transducer, (d) piezoresistive pressure sensor

A very important part of the motor is the exhaust nozzle. Testing in laboratory-scale motors indicates that the best and most reliable results are obtained with appropriate nozzle diameters (in the range of several mm). The nozzles were made with high precision from a suitable material, namely graphite rod. Designs of ejector nozzles and examples of their construction are shown in Figure 3.

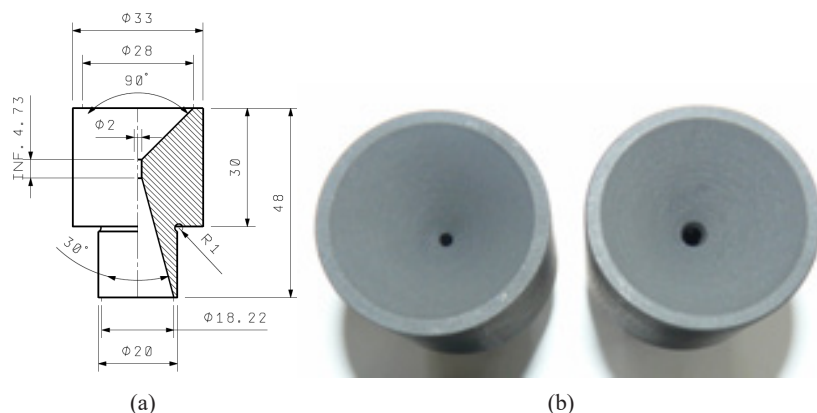

Figure 3. Design of 2 mm diameter ejector nozzle (a) and examples of 1 and 3 mm diameter ready nozzles (b)

2.2. Preparation of propellant samples for ignition in the laboratory-scale motor

Domestically produced nitrocellulose/nitroglycerine propellants, sold under the trade names *Szmaragd*[®] and *Szafir*[®], mixtures of these propellants in the ratio 1:1 (Sz/Sz), (Figure 4(b)), and modified single-base propellants marked as No. 1 (Figure 4(c)) and No. 2 (Figure 4(a)) were selected for efficacy tests in the motor. The powdered propellants in granular form are shown in Figure 4. Propellants No. 1 and 2 were based on nitrocellulose and modified with the addition of dibutyl phthalate and titanium oxide or graphite, respectively. Propellant samples were made using die press technology. Propellant granules with the addition of a binder in the form of nitrocellulose lacquer were pressed in a prepared die (Figure 5). The addition of a binder turned out to be apposite in obtaining the proper mouldings. Figure 6 shows examples of the pressed propellants.



(a)

(b)

(c)

Figure 4. View of granulated propellants: (a) modified No. 2, (b) *Szmaragd/Szafir* (Sz/Sz), (c) modified No. 1



Figure 5. View of the die for propellant pressing (23 mm diameter)



Figure 6. Examples of propellant mouldings prepared for testing in laboratory motors

The samples had appropriate dimensions, adapted to the size of the motor. The diameter of the mouldings was 23 mm. Table 1 presents the characteristics of the samples with their average dimensions and density.

Table 1. Dimensions and densities of propellant samples prepared for testing in a laboratory motor

No.	Propellant type	Moulding height [mm]	Moulding weight [g]	Density [$\text{g}\cdot\text{cm}^{-3}$]
1	Sz/Sz ^{a)}	96.6	61.9	1.50
2	Sz ^{b)}	98.1	61.6	1.47
3	Nr 1	110.6	61.5	1.29
4	Nr 2	109.3	61.7	1.31

a) Sz/Sz – Szmaragd/Szafir, b) Sz – Szmaragd

2.3. Determining the manner of inhibiting propellant surfaces

When preparing propellant samples for testing in the motor, inhibiting the propellant by the application of a local surface coating of non-combustible substances, should be included. This treatment aims to regulate the amount of available combustible surface and the amount of gas emitted, and thus ensure a controlled combustion process. An important operating parameter is the proper adhesion of the inhibited surface to the propellant, which is achieved by selecting a substance with suitable adhesion. Lack of adhesion or any air bubbles on the boundary of the charge and the inhibitor may lead to an uncontrolled development of the combustible surface and, as a result, to rupture of the motor chamber. In addition, the inhibitor layer must be sufficiently strong mechanically and resistant to the effects of the hot gas stream during motor operation [10, 11]. In this work, the most practical and effective solution for propellant inhibition turned out to be the application of a heat-resistant polyester film.

2.4. Determining the ignition initiation method for propellants samples

In order to conduct tests in the motor, it was necessary to develop an initiation system at the later stage of the work. A 10 mm deep and 5 mm diameter hole was made in the propellant sample, filled with PS pyrotechnic composition (about 200 mg). Then, in the upper layer of the channel filled with the PS composition, a heat-resistant igniting charge type GZ-0,2-Tr with power cables was placed. Figure 7 shows the method of preparing the ignition unit. In order to check the correct operation of the proposed igniting unit, a propellant sample was subjected to combustion tests (outdoors). The result of one of the tests is presented as photographs (Fig. 8). A nominal current of 0.8 A was used to energize the standard 0.2 A igniting charge. The proposed method of initiation proved effective for the other selected propellants.

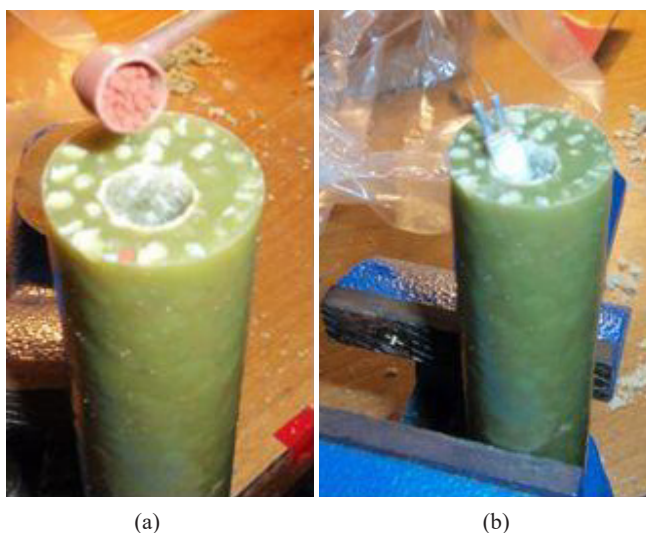
**Figure 7.** Preparation of the propellant ignition unit consisting of: (a) pyrotechnic composition, (b) igniting charge

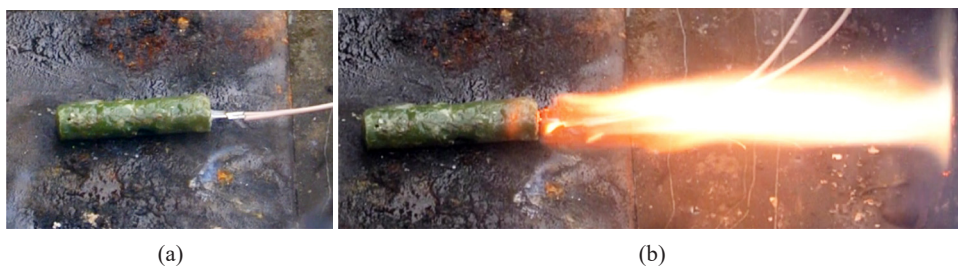

Figure 8. An example of initiating ignition of the propellant sample Sz – by means of an igniting charge together with the PS pyrotechnic composition

2.5. Testing in the laboratory-scale motor

In the next step, testing of the prepared samples in the laboratory motor was started. Samples based on the *Szmaragd/Szafir* and *Szmaragd* propellant with similar weight and physical dimensions were prepared. Figure 9(a) shows the moment of installation of the propellant sample in the motor chamber and assembly of the remaining elements (head, exhaust nozzle, wiring). A sample of the test propellant was placed in the vertically located motor body. The wiring of the igniter was threaded through the exhaust nozzle, and the motor head tightened.

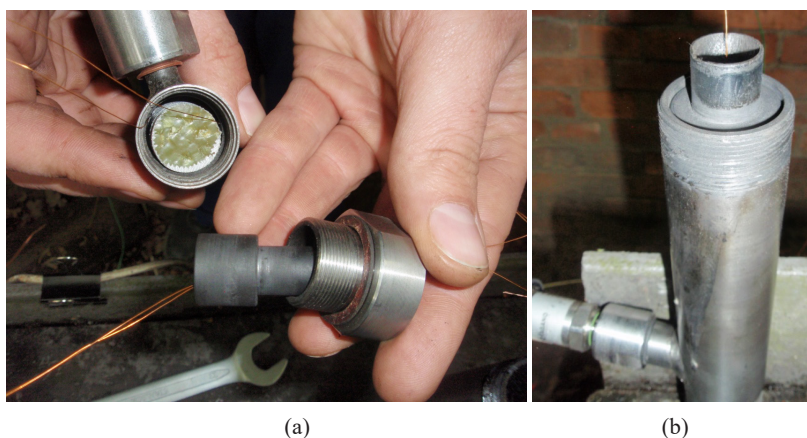

Figure 9. An example of the laboratory motor assembly

Figure 8 (b) shows a view of the motor chamber with test sample, enclosed by a graphite exhaust nozzle. The igniting charge wires and pressure transducer are visible at the bottom of the body. In the tests, pressure changes in the motor chamber were recorded using a digital oscilloscope, and the test process recorded concurrently by a high speed camera. The camera enabled the capture of the experiments. An example of an oscilloscope recording and a sequence from the digital recording of an image of one of the propellant combustion tests is shown in Figure 10.

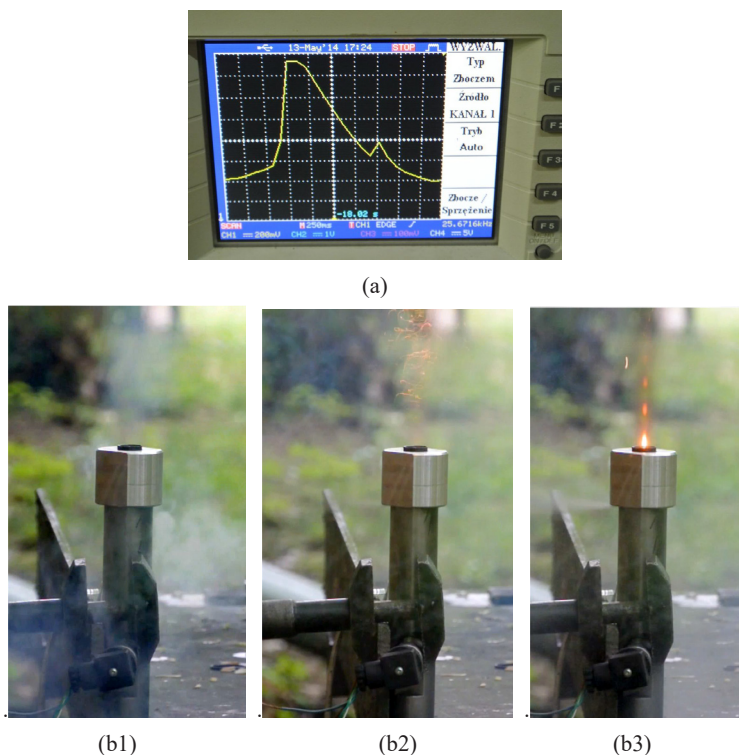

Figure 10. Example of pressure recording on the oscilloscope screen (a) and view of a working laboratory motor during a propellant combustion test at various points in time (b1, b2 and b3)

3. Results

The presented test results relate to basic thermodynamic analysis carried out for the propellants used in the tests: *Szmaragd* and *Szafir*. The analysis was performed using the program ICT Thermodynamic Code Version 1.0. Next, the results of the conducted tests of propellant combustion in the motor were discussed.

3.1. Thermodynamic analysis of the parameters

To conduct the analysis, knowledge of the qualitative and quantitative composition of the propellants is necessary. Table 2 shows the compositions in wt.% for propellants such as *Szmaragd* and *Szafir*.

Table 2. Compositions of *Szmaragd* and *Szafir* type propellants

Propellant components	Content [wt.%]	
	<i>Szmaragd</i>	<i>Szafir</i>
Nitroglycerine	26.5	40
Nitrocellulose	56	58
Centralite I (ethyl centralite)	9	1
DNT (dinitrotoluene)	3	–
DBP (dibutyl phthalate)	4.5	–
Vaseline	1	0.5

The analysis allowed the determination of such parameters as: oxygen balance, gas volume and heat of explosion under standard conditions and at constant volume ($V = \text{const.}$, propellant loading density $0.1 \text{ g}\cdot\text{cm}^{-3}$) and specific impulse under standard conditions and at constant pressure ($p \text{ const.} = 70 \text{ bar}$). Table 3 summarizes these parameters.

Table 3. Thermodynamic parameters for *Szmaragd* and *Szafir* propellants obtained in the ICT code

Parameter	<i>Szmaragd</i>	<i>Szafir</i>
Theoretical density [$\text{g}\cdot\text{cm}^{-3}$]	1.545	1.611
Oxygen balance [%]	-52.14	-25.40
The volume of gaseous products [$\text{cm}^3\cdot\text{g}^{-1}$]	912.3	712.6
The volume of gaseous products in relation to the volume unit of propellant [$\text{cm}^3\cdot\text{ml}^{-1}$]	1409	1148
Quantity of gaseous products [$\text{mol}\cdot\text{kg}_{\text{expl.}}^{-1}$]	37.289	29.127
Heat of explosion [$\text{J}\cdot\text{g}^{-1}$]	3396.6	4847.0
Specific impulse ($p = \text{const.} = 70 \text{ bar}$) [s]	209.8	241.3

For propellants to be used in downhole fracturing applications, it is important to know the amount of gas generated per propellant unit volume. In ready-made devices, the space for propellant or propellant element storage is usually limited. The above analysis shows that the *Szmaragd* type propellant generates a much larger volume of gas than the *Szafir* type propellant (by about 25%). In addition, it is possible to compare *Szafir* and *Szmaragd* propellants using the thermodynamic data collected in Table 3. The *Szafir* propellant is a higher energy propellant than *Szmaragd*. Decomposition processes are accompanied by the release of more heat and higher parameters of this process (temperature and pressure). These dependencies result from the composition of the exhaust from clean propellants.

3.2. Test results of ignition and combustion of propellants in the laboratory-scale motor

Two types of propellants based on the *Szmaragd* propellant and the *Szmaragd/Szafir* compound were tested in the motor. The tests were carried out using a 3 mm diameter motor exhaust nozzle. The samples were inhibited with heat-resistant polyester film. The results of igniting the propellants are presented in the form of the graphs of pressure changes during combustion of the propellants in the motor. Instrumentation consisted of a digital oscilloscope (Gw INSTRON GDS-2204 – maximum sampling rate of $1 \text{ GS}\cdot\text{s}^{-1}$), which recorded the signal from the piezoresistive pressure sensor ADZ NAGANO series SML-31.0. Sensor parameters are given in Table 4. For data acquisition, a PC computer with Microsoft Office EXCEL 2003 software was used. Figure 11 shows a typical pressure curve of the combustion of the Sz/Sz propellant sample recorded on the oscilloscope screen.

Table 4. Technical parameters of the ADZ NAGANO pressure sensor series SML-31.0

Parameter	Measurement unit	Value for the sensor
Measuring range	[MPa]	0-16
Sampling	[ms]	<1
Output signal	[V]	0.5-4.5

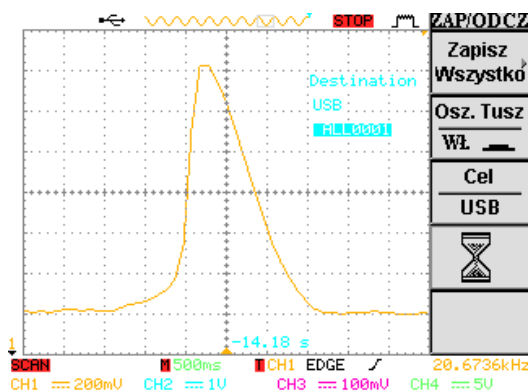

Figure 11. The course of the pressure changes during the combustion of the Sz/Sz propellant in the laboratory motor

Table 5 summarizes the test results in the form of maximum pressure values and pressure pulse for the tested samples. Figure 12 presents pressure profiles for individual tested samples.

Table 5. Maximum pressure and pressure impulse for tested propellant samples in the laboratory motor

Sample No.	Type of propellant	Sample weight [g]	Maximum pressure [MPa]	Pressure pulse [MPa·s]
1	<i>Szmaragd/Szafir</i>	49	4.58	3.94
2		54	4.92	3.33
3		62	6.46	5.07
4	<i>Szmaragd</i>	62	2.15	3.33

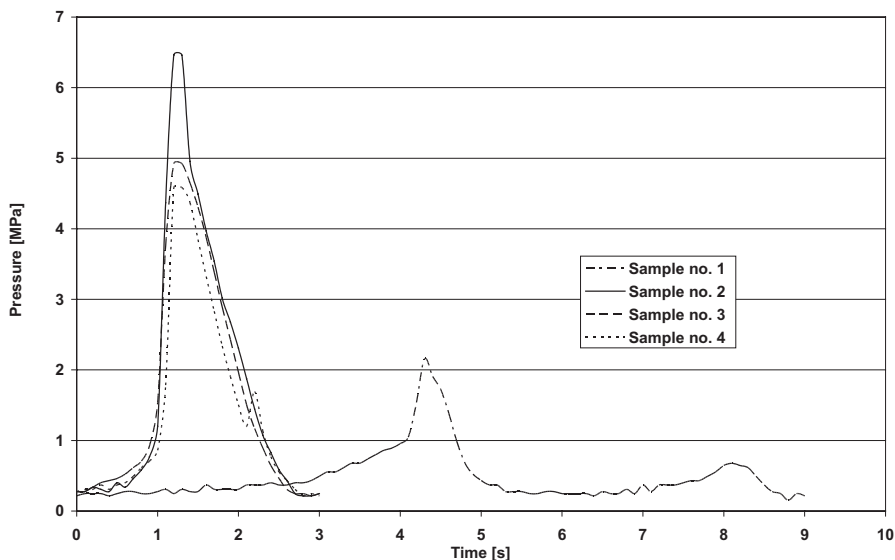

Figure 12. Graphs $p = f(t)$ for samples 1, 2, 3 and 4

The tests of selected propellants carried out in the motor demonstrate that, for the Sz/Sz propellant, higher pressure values were achieved than for the *Szmaragd* propellant (sample No. 4). In addition, in the case of the *Szmaragd*

propellant, a significantly longer time to ignition of the sample was observed. The recorded pressure changes over time for the Sz/Sz propellant (samples 1-3) show the same pressure profiles with a width of approx. 1.5 s and maximum pressure values depending on the mass of the tested sample.

4. Conclusions

The issues presented concern the tests of selected solid propellants, their properties and energy parameters in terms of their potential use in oil wells in gas fracking operations. Discussion of the results lead to the following conclusions:

- 4.1. Thermodynamic analysis (ICT) tools were used for a series of tests of the energy parameters of propellants and various propellant compounds.
- 4.2. An effective electric system for the initiation of propellant samples was implemented.
- 4.3. To obtain test samples of the desired cylindrical shape, the technology of pressing the propellants or their compounds in granular form was used with a nitrocellulose based binder.
- 4.4. A method of inhibiting test propellant samples was selected.
- 4.5. A series of tests was carried out on selected propellants, confirming the effectiveness of the selected ignition system.
- 4.6. On account of the efficacy of igniting the test samples in the laboratory-scale motor, more favourable properties were determined for the *Szmaragd/Szafir* propellant than for the *Szmaragd* propellant. A nearly three times longer sample ignition time was observed for the *Szmaragd* propellant.

References

- [1] www.balticceramicsinvestments.com [accessed 20.01.2014].
- [2] Rogala A., Księżniak K. 2013. Alternative fracturing technologies in shale gas extraction. (in Polish, ed. transl.) Clean energy forum, Poznań, www.czystaenergia.pl/pdf/poleko2013/08/12.pptx [accessed 8.10.2013].
- [3] Frodyma A., Habera Ł. 2013. The principles of propellants physical interactions in borehole and reservoir rocks environment and their implications for stimulation jobs. (in Polish) *Materialy Wysokoenergetyczne / High Energy Materials* 5: 59-71.
- [4] *Research on the modification of propellants intended for application in the technology of dry fracturing of hydrocarbon deposits from shale formations.* (in Polish, ed. transl.) IPO Statutory work No. EMC 014002213, 2014.
- [5] *Research on the effectiveness of shaped charges and a selected propellant group intended for intensification of oil and gas extraction.* (in Polish, ed. transl.) IPO Report no. 10000216, 2013.
- [6] Barrere M., Jaumotte A., de Veubeke B.F., Vandekerckhove J. 1960. *Rocket Propulsion*. Elsevier Publishing Comp. : Amsterdam/London/New York/Princeton.
- [7] Florczak B., Witkowski W. 2006. Development perspectives for solid heterogeneous rocket propellants. (in Polish) *Problemy Techniki Uzbrojenia* 35 (98): 67-78.
- [8] Buchalik K., Florczak B., Lipiński M. 2001. Solid rocket propellants – present state and perspectives of development. (in Polish, ed. transl.) *Problemy Techniki Uzbrojenia* 78 (3): 129-142.
- [9] Florczak B., Lipińska K. 2011. Thermochemical Properties of Composite Propellants Combustion Products. *New Trends Res. Energ. Mater., Proc. Semin., 14th*, Pardubice, Czech Republic, 86-98.
- [10] Wolszakiewicz T. 2013. *Ballistic and strength tests of solid rocket propellants in the aspect of correct ignition and the possibility of the occurrence of emergency situations in the operation of rocket motors.* (in Polish, ed. transl.) IPO, Warszawa; ISBN 9788391492222.
- [11] Florczak B., Wolszakiewicz T., Marzec A. 2006. *Solid rocket propellant.* (in Polish, ed. transl.) Patent PL 207094B1.

Polish version:

The work was originally published in Polish, in the *High Energy Materials* journal (*Materiały Wysokoenergetyczne*) 2014 (6): 5-14. The Polish version is available in PDF-format, in colour, at:

http://www.wydawnictwa.ipo.waw.pl/materialy-wysokoenergetyczne/materialy-wysokoenergetyczne6/HEM_0099.pdf

English version:

– Revised: November 28, 2019

– Published first time online: December 10, 2019